

# COMPONENTI PER RICIRCOLO

<b>BOCCHETTE ABS DI MANDATA</b>	<b>pag.</b>	<b>62</b>
<b>BOCCHETTE ABS DI ASPIRAZIONE</b>	<b>pag.</b>	<b>64</b>
<b>PASSANTI A MURO ABS</b>	<b>pag.</b>	<b>66</b>
<b>SCARICHI DI FONDO ABS</b>	<b>pag.</b>	<b>67</b>
<b>SKIMMER ABS</b>	<b>pag.</b>	<b>69</b>
<b>REGOLATORE DI LIVELLO ABS</b>	<b>pag.</b>	<b>71</b>
<b>BOCCHETTE INOX</b>	<b>pag.</b>	<b>72</b>
<b>SKIMMER INOX</b>	<b>pag.</b>	<b>75</b>
<b>SCARICO DI FONDO INOX</b>	<b>pag.</b>	<b>77</b>



# BOCCHETTE ABS DI MANDATA A PARETE

## Tipo "P"

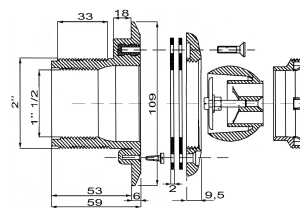
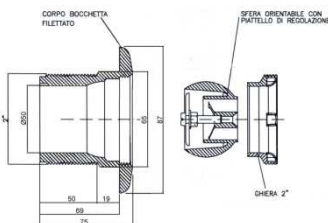

C.A.

LINER

CODICE	DESCRIZIONE	PREZZO € / UN	ATTACCO INTERNO	ATTACCO ESTERNO	PORTATA m <sup>3</sup> /h	INSTALLAZIONE
020102040	BOCCHETTA DI MANDATA ABS "P" x CA	11,01	Ø 50	2" M	~ 5	C.A.
020102041	BOCCHETTA DI MANDATA ABS "P" x LINER	22,87	1 1/2" F	2" M	~ 5	LINER

- Rispettano la normativa UNI 10637.
- Si consiglia l'uso del passante a muro codice 020104010.

## Tipo "A"

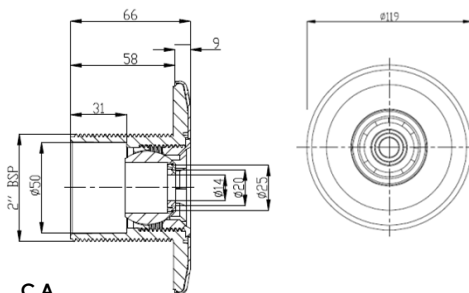

C.A.

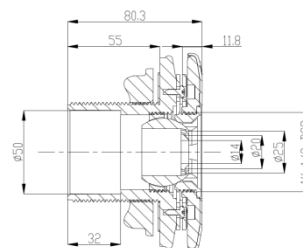

LINER

CODICE	DESCRIZIONE	PREZZO € / UN	ATTACCO INTERNO	ATTACCO ESTERNO	PORTATA m <sup>3</sup> /h	INSTALLAZIONE
020102020	BOCCHETTA DI MANDATA ABS PER CA	12,57	Ø 50	2"	*	C.A.
020102021	BOCCHETTA DI MANDATA ABS PER LINER	26,67	Ø 50	2"	*	LINER

- Sfera diametro regolabile per la modulazione del flusso/portata.

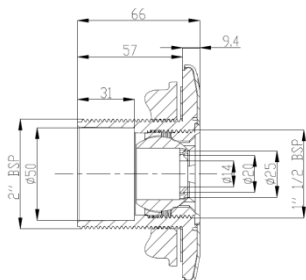

- \* Portata differenziata in base al diametro:  
 Ø 14 mm portata 2,2 m<sup>3</sup>/h;  
 Ø 20 mm portata 4,5 m<sup>3</sup>/h;  
 Ø 25 mm portata 7 m<sup>3</sup>/h.

CODICE	DESCRIZIONE	PREZZO € / UN	ATTACCO INTERNO	ATTACCO ESTERNO	PORTATA m <sup>3</sup> /h	INSTALLAZIONE
020102022	BOCCHETTA DI MANDATA ABS PER VTR	16,02	Ø 50	2"	-	VTR

- Sfera diametro regolabile per la modulazione del flusso/portata.
- Diametro: 119 mm.

# BOCCHETTE ABS DI MANDATA A PAVIMENTO

## Tipo "P"

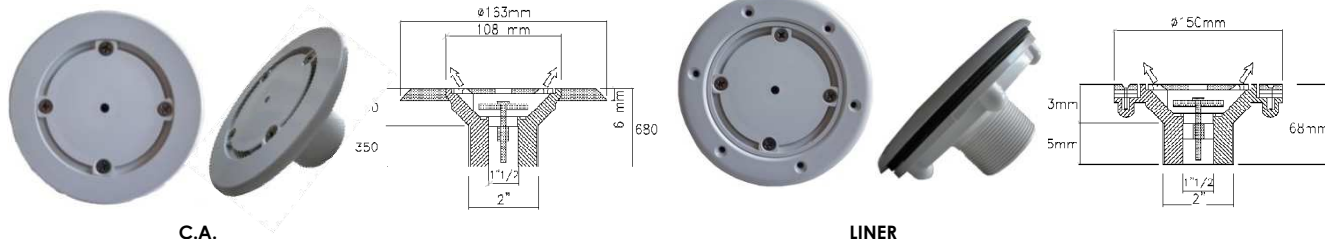

CODICE	DESCRIZIONE	PREZZO € / UN	ATTACCO INTERNO	ATTACCO ESTERNO	PORTATA m <sup>3</sup> /h	INSTALLAZIONE
020102005	BOCCHETTA DI MAND. A PAV. ABS PER CA	27,14	1 1/2" F	2" M	~ 5	C.A.
020102006	BOCCHETTA DI MAND. A PAV. ABS C.A.+LINER	40,59	1 1/2" F	2" M	~ 5	LINER

- Montaggio a pavimento.

## Tipo "A"



CODICE	DESCRIZIONE	PREZZO € / UN	ATTACCO INTERNO	ATTACCO ESTERNO	PORTATA m <sup>3</sup> /h	INSTALLAZIONE
020102026	BOCCHETTA DI MAND. A PAV. ABS PER CA	12,08	Ø 50	2"	~ 9,5	C.A.
020102027	BOCCHETTA DI MAND. A PAV. ABS C.A.+LINER	32,37	Ø 50	2"	~ 9,5	LINER

- Montaggio a pavimento.



CODICE	DESCRIZIONE	PREZZO € / UN	ATTACCO INTERNO	ATTACCO ESTERNO	PORTATA m <sup>3</sup> /h	INSTALLAZIONE
020102028	BOCCHETTA DI MAND. A PAV. ABS PER CA	15,81	Ø 63	-	~ 13,5	C.A.
020102029	BOCCHETTA DI MAND. A PAV. ABS C.A.+LINER	31,31	Ø 63	-	~ 13,5	LINER

## Clip e piattello



- Piattello in ABS diametro 120.
- Installabile su tubazioni Ø 50 e 63 mm.

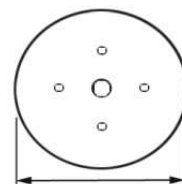

CODICE	DESCRIZIONE	PREZZO € / UN	INSTALLAZIONE
020102007	BOCCHETTA DI MAND. C/PIATTELLO X Ø 50 e 63 mm	37,05	C.A.

# BOCCHETTE ABS DI ASPIRAZIONE

## Aspirafango Tipo "P"



C.A.

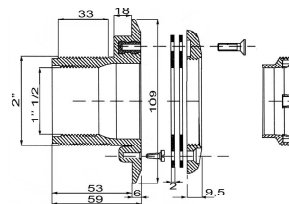
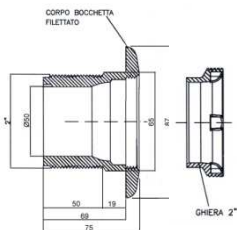

CODICE	DESCRIZIONE	PREZZO € / UN	ATTACCO INTERNO	ATTACCO ESTERNO	PORTATA m <sup>3</sup> /h	INSTALLAZIONE
020102042	BOCCHETTA ASPIRAFANGO ABS "P" x CA	9,28	Ø 50	2" M	-	C.A.
020102043	BOCCHETTA ASPIRAFANGO ABS "P" PER LINER	18,43	1 1/2" F	2" M	-	LINER

- Si consiglia l'uso del passante a muro codice 020104010.
- E' possibile utilizzare la bocchetta per l'aspirazione munendola della griglia codice 020102044.

## Aspirafango Tipo "A"

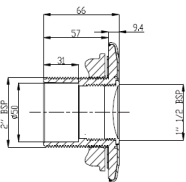

C.A.

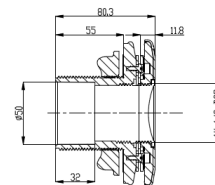
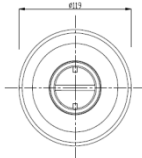

LINER

CODICE	DESCRIZIONE	PREZZO € / UN	ATTACCO INTERNO	ATTACCO ESTERNO	PORTATA m <sup>3</sup> /h	INSTALLAZIONE
020102023	BOCCHETTA ASPIRAFANGO ABS PER CA	9,07	Ø 50	2"	~ 7	C.A.
020102024	BOCCHETTA ASPIRAFANGO ABS PER LINER	23,28	Ø 50	2"	~ 7	LINER

- Tappo filetto F 1 1/2".
- E' possibile installare il raccordo maschio aspira fango codice 020102025.

## Aspirazione Tipo "Neptun"

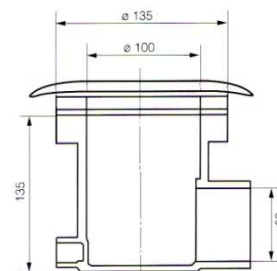

CODICE	DESCRIZIONE	PREZZO € / UN
020102015	BOCCHETTA ASPIRAZIONE CA + LINER ATT. Ø 63 F	57,40
020102016	GUARNIZIONE SANDWICH 3"	14,65

- Utilizzo sia a pavimento che a parete.

# BOCCHETTE ABS DI ASPIRAZIONE

## Aspirazione Tipo "P"



020102042

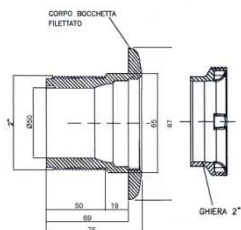

020102043

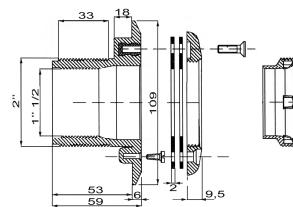

020102044



020102045

CODICE	DESCRIZIONE	PREZZO € / UN	ATTACCO INTERNO	ATTACCO ESTERNO	PORTATA m <sup>3</sup> /h	INSTALLAZIONE
020102042	BOCCHETTA ABS "P" x CA	9,28	Ø 50	2" M	-	C.A.
020102043	BOCCHETTA ABS "P" PER LINER	18,43	1 1/2" F	2" M	-	LINER
020102044	GRIGLIA PER BOCCHETTA DA 2"	3,29	-	-	-	-
020102045	TAPPO PER BOCCHETTA DA 2"	3,29	-	-	-	-

- Si consiglia l'uso del passante a muro codice 020104010.

## ACCESSORI BOCCHETTE ABS DI ASPIRAZIONE

### Ghiera di installazione bocchette su pannello



CODICE	DESCRIZIONE	PREZZO € / UN	ATTACCO INTERNO	INSTALLAZIONE
120401019	GHIERA CON DISTANZIALE 2"	9,03	2" F	LINER

- Da utilizzare con bocchette codici: 020102040 – 020102041 – 020102042 - 020102043.

### Raccordo attacco aspirafango



CODICE	DESCRIZIONE	PREZZO € / UN
020102025	RACCORDO ATTACCO ASPIRAFANGO	2,54

- Raccordo filettato per attacco a bocchetta 1 1/2".

# PASSANTI A MURO

## Passanti a muro in ABS CORTO



CODICE	DESCRIZIONE	PREZZO € / UN	ATTACCHI	LUNGHEZZA cm	INSTALLAZIONE
020104011	PASSANTE A MURO ABS	7,64	2" X 1 1/2"	24,6	C.A.
020104012	PASSANTE A MURO ABS	7,51	50 X 2"	24,6	C.A.

## Passanti a muro in ABS MEDIO

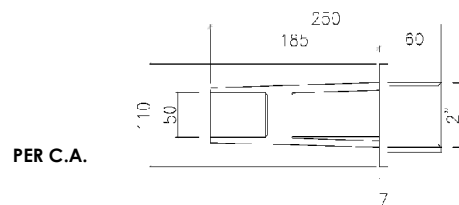

CODICE	DESCRIZIONE	PREZZO € / UN	ATTACCHI	LUNGHEZZA cm	INSTALLAZIONE
020104008	PASSANTE A MURO ABS PER CA	24,36	2" X 50/63	25	C.A.

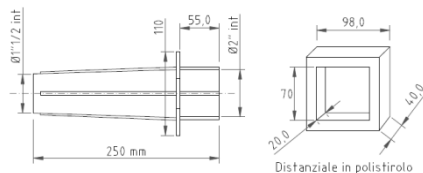

CODICE	DESCRIZIONE	PREZZO € / UN	ATTACCHI	LUNGHEZZA cm	INSTALLAZIONE
020104010	PASSANTE A MURO PVC PER C.A.+ LINER	13,55	2" X 1 1/2"	25	C.A. + LINER

## Passanti a muro LUNGO



CODICE	DESCRIZIONE	PREZZO € / UN	ATTACCHI	LUNGHEZZA cm	INSTALLAZIONE
020104013	PASSANTE A MURO PVC GRIGIO	7,98	2"	30,0	C.A.

# SCARICHI DI FONDO

## Tipo "P"



020103001

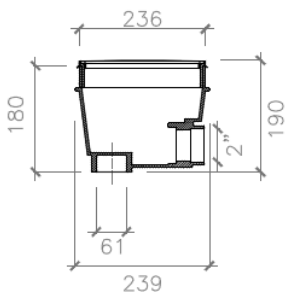

020103002

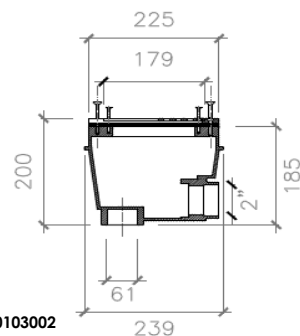

CODICE	DESCRIZIONE	PREZZO € / UN	ATTACCHI	PORTATA m <sup>3</sup> /h	INSTALLAZIONE
020103001	SCARICO DI FONDO ABS PER CA	50,40	1 1/2" - 2"	~ 13	C.A.
020103002	SCARICO DI FONDO ABS PER LINER	77,20	1 1/2" - 2"	~ 13	C.A. + LINER

- Con inserti in ottone per flangia.
- Le versioni per liner includono guarnizioni adesive in gomma.

## Tipo "A"



020103005

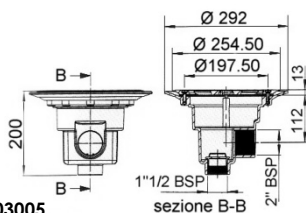

020103006

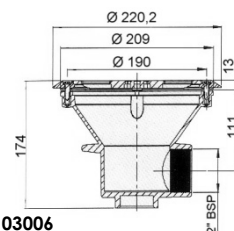

CODICE	DESCRIZIONE	PREZZO € / UN	ATTACCHI	PORTATA m <sup>3</sup> /h	INSTALLAZIONE
020103005	SCARICO DI FONDO ABS	64,40	1 1/2"	~ 13	LINER
020103006	SCARICO DI FONDO ABS	50,20	2"	~ 13	LINER

- Costruito in materiali plastici ABS totalmente inalterabili.

## Quadrato 210 x 210 mm

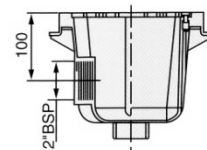
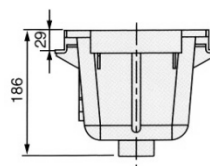
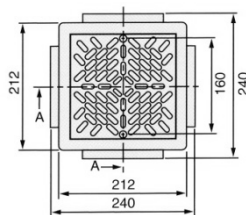

CODICE	DESCRIZIONE	PREZZO € / UN	ATTACCHI	PORTATA m <sup>3</sup> /h	INSTALLAZIONE
020103003	SCARICO DI FONDO QUADRATO ABS PER CA	22,54	2"	~ 13	C.A.
020103004	SCARICO DI FONDO QUADRATO ABS PER LINER	66,40	2"	~ 13	C.A. + LINER



# SCARICHI DI FONDO

## Per PISCINE PUBBLICHE



250x250

CODICE	DESCRIZIONE	PREZZO € / UN	ATTACCHI	PORTATA m <sup>3</sup> /h	INSTALLAZIONE
020105001	SCARICO DI FONDO 250x250 PER C.A. – 75	231,00	75	19	C.A.
020105002	SCARICO DI FONDO 250x250 PER C.A. – 90	235,65	90	28	C.A.
020105003	SCARICO DI FONDO 250x250 PER C.A. – 110	250,90	110	40	C.A.
020105004	SCARICO DI FONDO 250x250 PER LINER – 75	498,70	75	19	LINER
020105005	SCARICO DI FONDO 250x250 PER LINER – 90	507,80	90	28	LINER
020105006	SCARICO DI FONDO 250x250 PER LINER – 110	544,30	110	40	LINER

- Realizzato in poliestere rinforzato con fibra di vetro.
- Griglia 250x250 mm realizzata in PVC .



310x310

- Realizzato in ABS con griglia antivortice.
- Dimensioni: 310 mmx310mm, altezza 230; griglia in ABS 260 mm x 260 mm.
- Inserti a bussola e viti in acciaio inox AISI 316 per il mod. liner.
- **Conforme alla normativa UNI per uso pubblico e UNI13451.**

CODICE	DESCRIZIONE	PREZZO € / UN	ATTACCHI	PORTATA		INSTALLAZIONE		
				Vel 0,5 m <sup>3</sup> /h	Vel 0,3 m <sup>3</sup> /h			
				Ø110	Ø125	Ø90	Ø125	
020105017	SCARICO DI FONDO 310X310-UNI-PER C.A.	173,00	125M/110F	49,59	52,71	31,62	33,84	C.A.
020105018	SCARICO DI FONDO 310X310-UNI-PER LINER	209,00	125M/110F	49,59	52,71	31,62	33,84	LINER

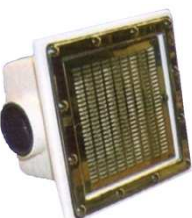

480x480

CODICE	DESCRIZIONE	PREZZO € / UN	ATTACCHI	PORTATA m <sup>3</sup> /h	INSTALLAZIONE
020105007	SCARICO DI FONDO 480x480 PER C.A. – 125	562,50	125	52	C.A.
020105008	SCARICO DI FONDO 480x480 PER C.A. – 140	568,61	140	66	C.A.
020105009	SCARICO DI FONDO 480x480 PER C.A. – 160	585,40	160	89	C.A.
020105010	SCARICO DI FONDO 480x480 PER C.A. – 200	630,90	200	94	C.A.
020105011	SCARICO DI FONDO 480x480 PER LINER – 125	888,00	125	52	LINER
020105012	SCARICO DI FONDO 480x480 PER LINER – 140	895,00	140	66	LINER
020105013	SCARICO DI FONDO 480x480 PER LINER – 160	912,00	160	89	LINER
020105014	SCARICO DI FONDO 480x480 PER LINER – 200	954,00	200	94	LINER

- Realizzato in poliestere rinforzato con fibra di vetro.
- Griglia 480x480 mm realizzata in acciaio inossidabile AISI 304L .



CODICE	DESCRIZIONE	PREZZO € / UN	V	PORTATA (consigliata) m <sup>3</sup> /h	V	PORTATA (massima) m <sup>3</sup> /h
020105015	COPERTURA ANTIVORTICE 250x250 mm	153,60	0,3 m/s	23,8	0,5 m/s	39,7
020105016	COPERTURA ANTIVORTICE 480x480 mm	367,70	0,3 m/s	56,0	0,5 m/s	94,0

- Realizzata in PVC.



# SKIMMER ABS

## Mini skimmer

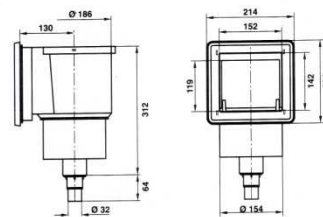

CODICE	DESCRIZIONE	PREZZO € / UN	ATTACCHI	PORTATA m <sup>3</sup> /h	INSTALLAZIONE
150201000	SKIMMER MINI ABS F/T	54,90	32 / 1 ½ F	-	-

- Provvisto di bocchetta.

## Skimmer bocca standard

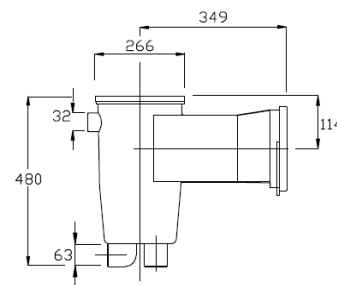
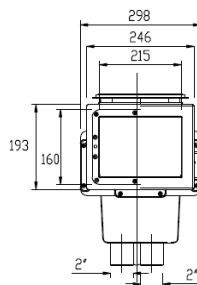

CODICE	DESCRIZIONE	PREZZO € / UN	ATTACCHI	PORTATA m <sup>3</sup> /h	INSTALLAZIONE
020101001	SKIMMER ABS B/STANDARD CA	115,50	1 ½" – 2"	~ 7,5	C.A.
020101002	SKIMMER ABS B/STANDARD LINER	126,90	1 ½" – 2"	~ 7,5	C.A. + LINER

- Bocca standard con coperchio quadrato.
- Con cestello, battente galleggiante antirumore, copriflangia, inserti in ottone.
- Le versioni per liner includono guarnizioni adesive in gomma.

## Skimmer bocca svasata

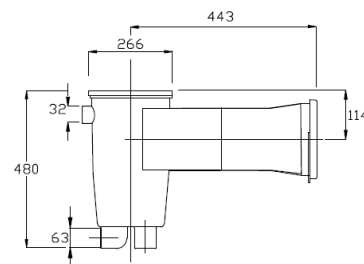
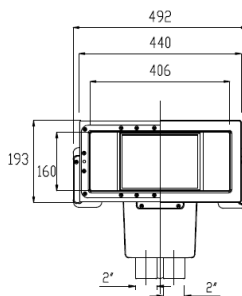

CODICE	DESCRIZIONE	PREZZO € / UN	ATTACCHI	PORTATA m <sup>3</sup> /h	INSTALLAZIONE
020101003	SKIMMER ABS B/SVASATA CA	126,00	1 ½" – 2"	~ 7,5	C.A.
020101004	SKIMMER ABS B/SVASATA LINER	137,50	1 ½" – 2"	~ 7,5	C.A. + LINER

- Bocca svasata con coperchio quadrato.
- Con cestello, battente galleggiante antirumore, copriflangia, inserti in ottone.
- Le versioni per liner includono guarnizioni adesive in gomma.

# SKIMMER ABS

## Skimmer bocca standard c/flangia inox



- Flangia inox in acciaio AISI 316.

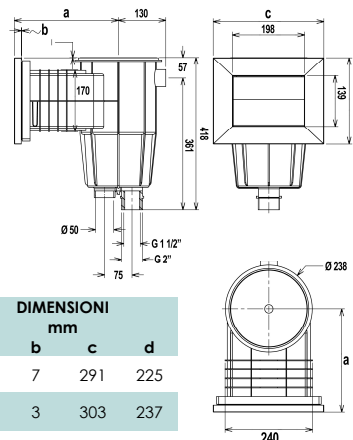

CODICE	DIMENSIONI mm			
	a	b	c	d
020102030	264	7	291	225
020102031	285	3	303	237

CODICE	DESCRIZIONE	PREZZO € / UN	ATTACCHI	PORTATA m <sup>3</sup> /h	INSTALLAZIONE
020101030	SKIMMER ABS B/STD C/FLANGIA INOX CA	416,00	1"½ F - 2" M Ø 50	7	C.A.
020101031	SKIMMER ABS B/STD C/FLANGIA INOX LINER	428,00	1"½ F - 2" M Ø 50	7	LINER

## Skimmer bocca svasata c/flangia inox



- Flangia inox in acciaio AISI 316.

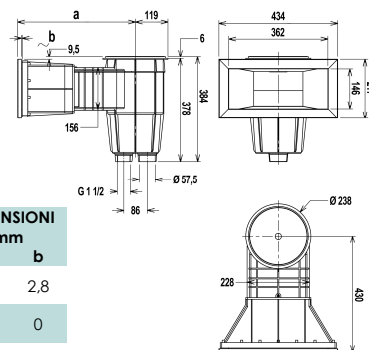

CODICE	DIMENSIONI mm	
	a	b
020102032	430	2,8
020102033	414	0

CODICE	DESCRIZIONE	PREZZO € / UN	ATTACCHI	PORTATA m <sup>3</sup> /h	INSTALLAZIONE
020101032	SKIMMER ABS B/SV. C/FLANGIA CA	522,00	1"½ F - 2" M Ø 50	7	C.A.
020101033	SKIMMER ABS B/SV. C/FLANGIA LINER	540,00	1"½ F - 2" M Ø 50	7	LINER

## Skimmer sfioratore

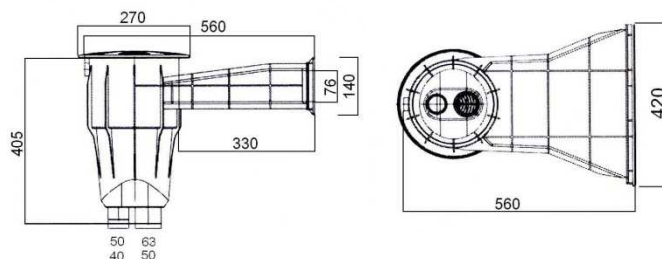

CODICE	DESCRIZIONE	PREZZO € / UN	ATTACCHI	PORTATA m <sup>3</sup> /h	INSTALLAZIONE
020101020	SKIMMER SFIORATORE x LINER	159,60	50 - 63	-	C.A. + LINER

- Skimmer in ABS con bocca svasata diritta, stampato in un pezzo unico.
- Progettato e realizzato per innalzare il livello dell'acqua fino a pochi centimetri dal bordo.
- Munito di sistema flottante.

# SKIMMER ABS

## Skimmer ad angolo

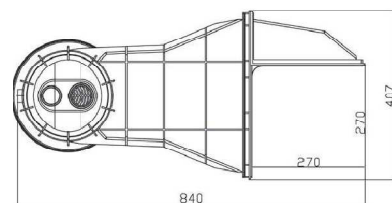
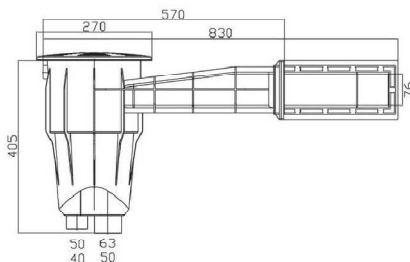
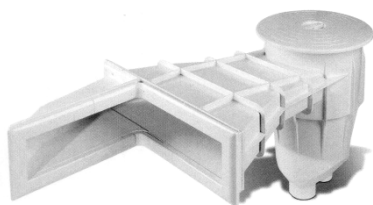

CODICE	DESCRIZIONE	PREZZO € / UN	ATTACCHI	PORTATA m <sup>3</sup> /h	INSTALLAZIONE
020101021	SKIMMER AD ANGOLO DX PER LINER	227,30	50 - 63	-	C.A. + LINER
020101022	SKIMMER AD ANGOLO SX PER LINER	227,30	50 - 63	-	C.A. + LINER

- Skimmer in ABS ad angolo, particolarmente indicato per la raccolta delle impurità che generalmente tendono ad accumularsi agli angoli.
- Progettato e realizzato per innalzare il livello dell'acqua fino a pochi centimetri dal bordo.
- Munito di sistema flottante.

## ACCESSORI SKIMMER ABS

### Complementi per skimmer in ABS



020101005



020101006



020101007



020101012



R0202008

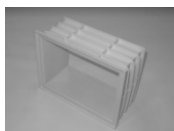

020101015

CODICE	DESCRIZIONE	PREZZO € / UN
020101005	DISTANZIATORE COPERCHIO SKIMMER	12,60
020101006	CESTELLO (H 12,00 - D.Sup 20,2 - D.Inf 15,0 cm)	15,75
020101007	COPERCHIO DI ASPIRAZIONE	14,49
020101012	GUARNIZIONE SANDWICH*	24,09
R0202008	BATTENTE SKIMMER	15,75
020101015	PROLUNGA BOCCA SKIMMER	18,00

\* Per skimmer bocca svasata

## REGOLATORE AUTOMATICO DI LIVELLO

### Regolatore automatico di livello in ABS

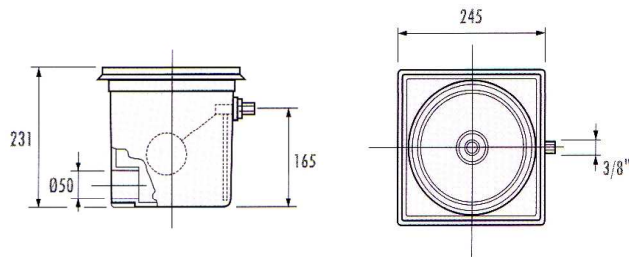

CODICE	DESCRIZIONE	PREZZO € / UN	ATTACCHI
020101010	REGOLATORE DI LIVELLO ABS	77,20	Ø 50 - 3/8"

# BOCCHETTE INOX

## Bocchette di mandata in acciaio inox AISI 316 a parete



VERSIONE PER C.A.



VERSIONE PER LINER

- Montaggio a parete.
- Con sfera orientabile.

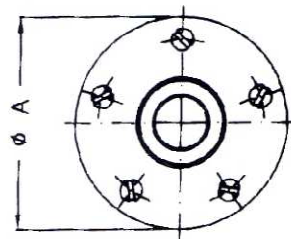
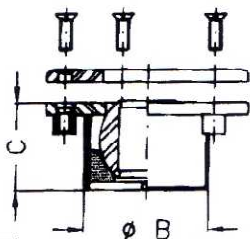

CODICE	DESCRIZIONE	PREZZO € / UN	PORTATA m <sup>3</sup> /h	DIMENSIONI mm			INST.
				A	B	C	
026002001	BOCCHETTA MAND. INOX C/ SFERA ORIENT. DA 1 1/2" PER C.A.	173,60	~ 7	96	1 1/2"	35	C.A.
026002002	BOCCHETTA MAND. INOX C/ SFERA ORIENT. DA 1 1/2" PER LINER	251,30	~ 7	96	1 1/2"	35	LINER
026002003	BOCCHETTA MAND. INOX C/ SFERA ORIENT. DA 2" PER C.A.	194,80	~ 12	104	2"	42	C.A.
026002004	BOCCHETTA MAND. INOX C/ SFERA ORIENT. DA 2" PER LINER	271,10	~ 12	104	2"	42	LINER
026002005	BOCCHETTA MAND. INOX C/ SFERA ORIENT. DA 2 1/2" PER C.A.	231,50	~ 7	120	2 1/2"	42	C.A.
026002006	BOCCHETTA MAND. INOX C/ SFERA ORIENT. DA 2 1/2" PER LINER	333,20	~ 7	120	2 1/2"	42	LINER
026002007	BOCCHETTA MAND. INOX C/ SFERA ORIENT. DA 3" PER C.A.	296,50	~ 12	135	3"	47	C.A.
026002008	BOCCHETTA MAND. INOX C/ SFERA ORIENT. DA 3" PER LINER	402,30	~ 12	135	3"	47	LINER

## Bocchette di mandata in acciaio inox AISI 316 a pavimento



VERSIONE PER C.A.



VERSIONE PER LINER

- Montaggio a fondo piscina. Con piattello regolabile.

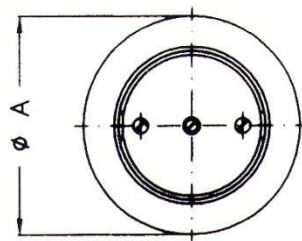
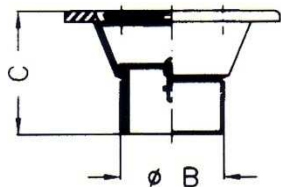

CODICE	DESCRIZIONE	PREZZO € / UN	PORTATA m <sup>3</sup> /h	DIMENSIONI mm			INST.
				A	B	C	
026002009	BOCCHETTA MAND. INOX REG. C/ PIATTELLO DA 2" PER C.A.	271,10	~ 5	145	2"	55	C.A.
026002010	BOCCHETTA MAND. INOX REG. C/ PIATTELLO DA 2" PER LINER	355,80	~ 5	145	2"	60	LINER
026002011	BOCCHETTA MAND. INOX REG. C/ PIATTELLO DA 3" PER C.A.	338,80	~ 10	158	3"	60	C.A.
026002012	BOCCHETTA MAND. INOX REG. C/ PIATTELLO DA 3" PER LINER	451,80	~ 10	158	3"	65	LINER

# BOCCHETTE INOX

## Bocchette di mandata in acciaio inox AISI 316 a parete



VERSIONE PER C.A.



VERSIONE PER LINER

- Montaggio a parete.
- Regolabili a farfalla.
- Lucidate a specchio.

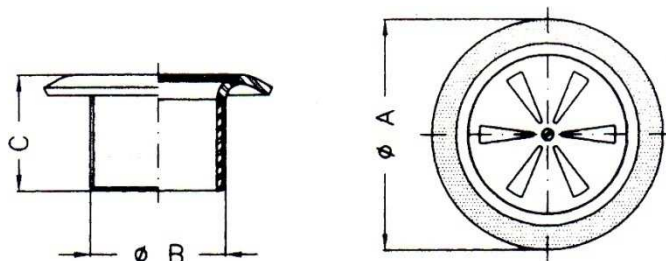

CODICE	DESCRIZIONE	PREZZO € / UN	PORTATA m <sup>3</sup> /h	DIMENSIONI mm			INST.
				A	B	C	
026002013	BOCCHETTA MAND. INOX REG. A FARFALLA DA 2" PER C.A.	197,70	~ 5	100	2"	42	C.A.
026002014	BOCCHETTA MAND. INOX REG. A FARFALLA DA 2" PER LINER	282,40	~ 5	122	2"	42	LINER
026002015	BOCCHETTA MAND. INOX REG. A FARFALLA DA 3" PER C.A.	271,10	~ 10	135	3"	47	C.A.
026002016	BOCCHETTA MAND. INOX REG. A FARFALLA DA 3" PER LINER	367,10	~ 10	145	3"	47	LINER

## Bocchette di mandata con clip in acciaio inox AISI 316 a pavimento



- Montaggio a fondo piscina con clip per tubazioni.

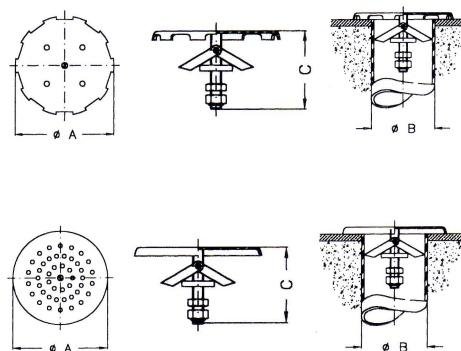

CODICE	DESCRIZIONE	PREZZO € / UN	DIMENSIONI mm			INST.
			A	B	C	
026002017	BOCCHETTA MAND. INOX AD INCASTRO C/CLIP PER TUBO 50/63	169,40	115	50-63	70	C.A.
026002018	BOCCHETTA MAND. INOX AD INCASTRO C/CLIP PER TUBO 75/90	167,70	135	75-90	70	C.A.
026002019	BOCCHETTA MAND. INOX TIPO KAISER C/CLIP PER TUBO 50/63	225,90	115	50-63	70	C.A.
026002020	BOCCHETTA MAND. INOX TIPO KAISER C/CLIP PER TUBO 75/90	262,60	135	50-63	70	C.A.



CODICE	DESCRIZIONE	PREZZO € / UN
026002040	BOCCHETTA INOX C/CLIP A FARFALLA 50/63	205,00

# BOCCHETTE INOX

## Bocchette aspirafango in acciaio inox AISI 316



VERSIONE PER C.A.

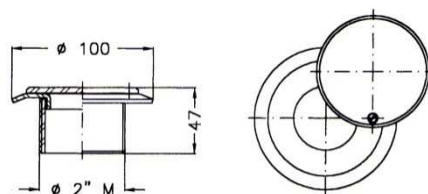

VERSIONE PER LINER

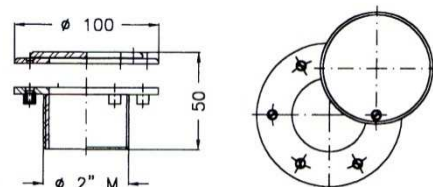

- Montaggio a parete, con piattello di chiusura.

CODICE	DESCRIZIONE	PREZZO €/ UN	PORTATA m <sup>3</sup> /h	DIMENSIONI mm			INST.
				A	B	C	
02600201	BOCCHETTA ASPIRAFANGO INOX DA 2" PER C.A.	194,80	~ 7	100	2"	47	C.A.
02600202	BOCCHETTA ASPIRAFANGO INOX DA 2" PER LINER	279,50	~ 7	100	2"	50	LINER

## Passanti a muro in acciaio inox AISI 316



VERSIONE PER C.A.

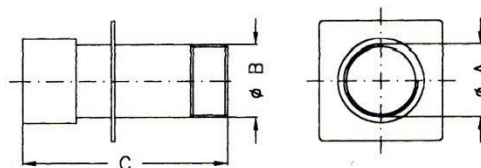

VERSIONE PER LINER

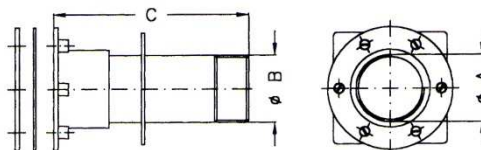

CODICE	DESCRIZIONE	PREZZO €/ UN	PORTATA m <sup>3</sup> /h	DIMENSIONI mm			INST.
				A	B	C	
026004023	PASSANTE A MURO INOX DA 1 1/2" PER C.A.	129,90	-	1 1/2" F	1 1/2" M	250-350	C.A.
026004024	PASSANTE A MURO INOX DA 1 1/2" C/FLANGE PER LINER	251,30	-	1 1/2" F	1 1/2" M	250-350	LINER
026004025	PASSANTE A MURO INOX DA 2" PER C.A.	183,50	-	1 1/2" F	1 1/2" M	250-350	C.A.
026004026	PASSANTE A MURO INOX DA 2" C/FLANGE PER LINER	279,50	-	2" F	2" M	250-350	LINER



# BOCCHETTE INOX

## Bocchette immissione aria in acciaio inox AISI 316



- Montaggio a parete.
- Ø foro: 3 mm.

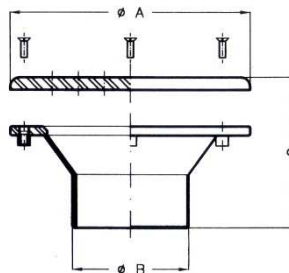

CODICE	DESCRIZIONE	PREZZO €/ UN	PORTATA m <sup>3</sup> /h	DIMENSIONI mm			INST.
				A	B	C	
026002027	BOCCHETTA IMMISSIONE ARIA INOX DA 2" PER C.A.	237,20	~ 30	125	2"	55	C.A.
026002028	BOCCHETTA IMMISSIONE ARIA INOX DA 2" PER LINER	310,60	~ 30	125	2"	60	LINER

## Bocchetta mini immissione aria in acciaio inox AISI 316



- Acciaio inox AISI 316 L.

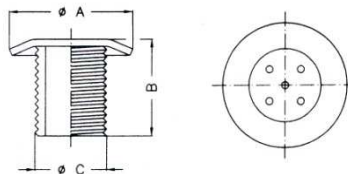

CODICE	DESCRIZIONE	PREZZO €/ UN	PORTATA m <sup>3</sup> /h	DIMENSIONI mm			INST.
				A	B	C	
026002029	BOCCHETTA MINI IMMISSIONE ARIA 3/8" M 3 FORI	53,60	-	31	25	3/8" M	C.A.
026002030	BOCCHETTA MINI IMMISSIONE ARIA 1/2" M 5 FORI	56,50	-	35	25	1/2" M	C.A.
026002031	BOCCHETTA MINI IMMISSIONE ARIA 3/4" M 7 FORI	62,10	-	40	32	3/4" M	C.A.

# SKIMMER INOX

## Skimmer in acciaio inox AISI 316 bocca standard



- Bocca standard.
- Con cestello inox.

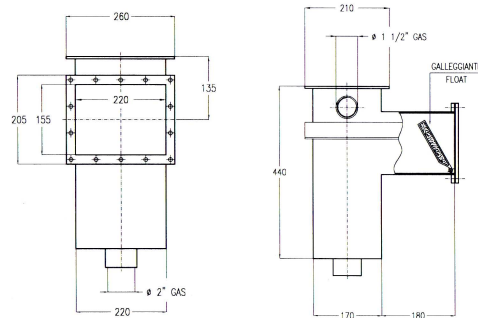

CODICE	DESCRIZIONE	PREZZO €/ UN	ATTACCHI	PORTATA m <sup>3</sup> /h	INSTALLAZIONE
026001001	SKIMMER INOX B/STANDARD PER CA	931,80	1 1/2" - 2"	5-9	C.A.
026001002	SKIMMER INOX STANDARD PER LINER	1.126,60	1 1/2" - 2"	5-9	LINER



# SKIMMER INOX

## Skimmer in acciaio inox AISI 316 bocca svasata e prolunga

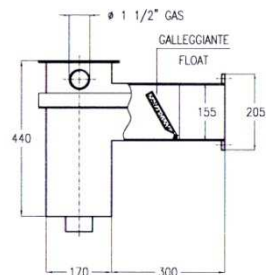
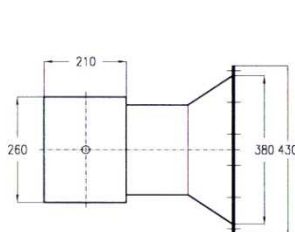

CODICE	DESCRIZIONE	PREZZO € / UN	ATTACCHI	PORTATA m <sup>3</sup> /h	INSTALLAZIONE
026001003	SKIMMER INOX B/SVAS. E PROL. PER CA	1.166,10	1 1/2" - 2"	5-9	C.A.
026001004	SKIMMER INOX B/SVAS. E PROL. PER LINER	1.420,30	1 1/2" - 2"	5-9	LINER

- Bocca svasata e prolunga.
- Con cestello inox.

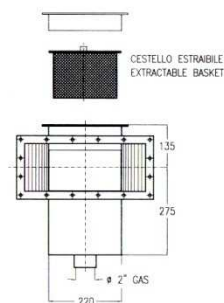

CODICE	DESCRIZIONE	PREZZO € / UN	ATTACCHI	PORTATA m <sup>3</sup> /h	INSTALLAZIONE
026001005	SKIMMER INOX B/SVAS. E PROL. PER C.A. - orizzontale	1.270,60	1 1/2" - 2"	5-9	C.A.
026001006	SSKIMMER INOX B/SVAS. E PROL. PER LINER- orizzontale	1.408,90	1 1/2" - 2"	5-9	LINER

- Bocca svasata e prolunga.
- Con cestello inox estraibile dalla bocca anteriore – modello orizzontale.

## Skimmer in acciaio inox AISI 316 bordo sfioro

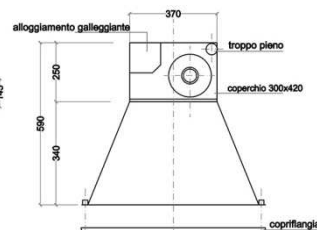
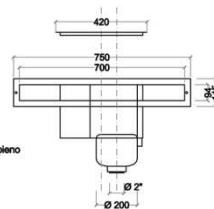
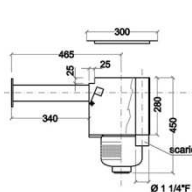

CODICE	DESCRIZIONE	PREZZO € / UN	ATTACCHI	PORTATA m <sup>3</sup> /h	INSTALLAZIONE
026001011	SKIMMER INOX B/SFIOR 700 mm x CA	1.747,10	2" F	-	C.A.
026001012	SKIMMER INOX B/SFIOR 700 mm x LINER	1.874,10	2" F	-	LINER
026001009	SKIMMER INOX B/SFIOR 700 mm x CA RIEMP. AUT. *	1.905,90	2" F	-	C.A.
026001010	SKIMMER INOX B/SFIOR 700 mm x LINER RIEMP. AUT. *	2.223,50	2" F	-	LINER

- \*Alloggiamento galleggiante per riempimento automatico.

# SCARICO DI FONDO INOX

## Scarico di fondo acciaio inox AISI 316

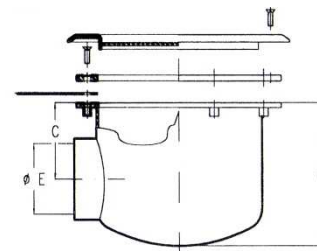
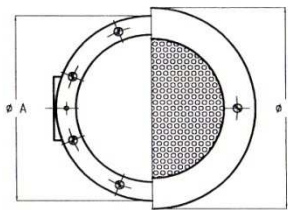

CODICE	DESCRIZIONE	PREZZO €/ UN	ATTACCHI	PORTATA m <sup>3</sup> /h	DIMENSIONI mm				INST.	
					Ø A	B	C	Ø D		Ø E
026003001	SCARICO DI FONDO INOX Ø 170 – 2" PER C.A.	310,60	2"	~ 20	170	125	165	190	2"-F	C.A.
026003002	SCARICO DI FONDO INOX Ø 170 – 2" PER LINER	397,10	2"	~ 20	170	125	165	190	2"-F	LINER

- Coperchio lucidato a specchio.

## Pozzetto di fondo acciaio inox AISI 316

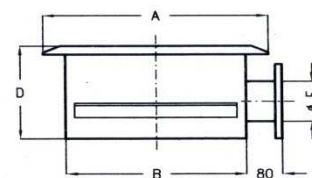
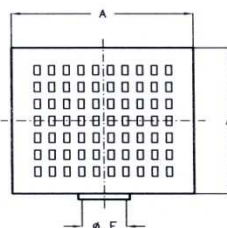
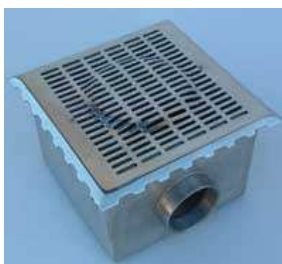

CODICE	DESCRIZIONE	PREZZO €/ UN	ATTACCHI	PORTATA m <sup>3</sup> /h	DIMENSIONI mm				INST.
					A	B	D	Ø E	
026003003	POZZETTO DI FONDO 30x30 PER C.A.	677,60	4"	~ 58	350	300	200	4" F	C.A.
026003004	POZZETTO DI FONDO 30x30 PER P.F.	841,40	4"	~ 58	350	300	200	4" F	LINER
026003005	POZZETTO DI FONDO 40x40 PER C.A.	1.524,70	DN 125	~ 78	450	400	290	DN 125	C.A.
026003006	POZZETTO DI FONDO 40x40 PER P.F.	1.807,10	DN 125	~ 78	450	400	290	DN 125	LINER

- Acciaio AISI 316 L.
- Attacco flangiato.

## Griglia di drenaggio in acciaio inox AISI 316

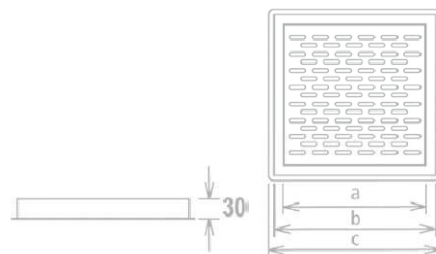

CODICE	DESCRIZIONE	PREZZO €/ UN	ATTACCHI	PORTATA m <sup>3</sup> /h	DIMENSIONI mm			INST.
					A	B	D	
026005210	GRIGLIA DI DRENAGGIO INOX 316 - 210x210	225,00	-	-	210	245	270	C.A.
026005305	GRIGLIA DI DRENAGGIO INOX 316 - 305x305	290,00	-	-	305	335	350	C.A.
026005450	GRIGLIA DI DRENAGGIO INOX 316 - 450x450	370,00	-	-	450	485	500	C.A.

- Acciaio AISI 316 L.